

The background of the page features several decorative, wavy lines composed of many thin, parallel lines. These lines curve across the page, creating a sense of motion and depth. They are positioned behind the main text.

Operation & Maintenance

AM 950 C | AM 950 F

AIRMASTER

SAFETY INSTRUCTIONS



- This manual must be read before using the Airmaster air handling unit. Compliance with the manual ensures correct use of this product.
- When using the unit in a room with a fire or stove drawing air from the room, all applicable provisions must be observed.
- The unit should not be used in rooms with abrasive particles or flammable or corrosive gas in the air, in wet rooms or explosion-protected rooms.
- The unit should not be used without the filters specified in this manual.
- The manufacturer cannot be held liable for damage arising from use in contravention of these instructions.
- The manufacturer reserves the right to make changes without notice. All values stated are nominal values and can be affected by local conditions.
- Failure to observe the warnings indicated by a danger symbol implies a risk of personal injury or damage to property.
- This guide relates to the Airmaster unit it accompanies plus all equipment and must be given to and saved by the unit's owner.

All necessary data and guides to network integration can be downloaded from www.airmaster-as.com

WARNINGS



The unit must be disconnected from mains electricity and precautions taken against accidental use before service covers can be opened..



The unit may not be started up until all service covers and grates on duct connections have been installed.



The installer must wear personal protective safety equipment, such as safety shoes, during the installation of the unit.

Place of installation and serial numbers:

Type	
Delivery date	
Serial number	
Place of installation	

Table of content

1	Function principle	6
2	LED Signals	7
2.1	Buzz warning	7
2.2	Buzz alarm	7
3	Control functions	8
3.1	Timer-controlled ventilation	8
3.2	Night time cooling	8
3.3	Holiday mode	8
3.4	Start and stop using external contacts	8
3.4.1	Built-in smoke detector	9
3.5	Start and stop using a PIR sensor	9
3.6	Control using a CO ₂ sensor	9
3.6.1	Air flow control	9
3.6.2	Start, stop and air flow control	10
3.7	Boost	10
3.8	Control using an analogue BMS	11
4	Internal control functions	12
4.1	Low temperature (Low Temp)	12
4.2	Preheat	12
4.3	High temperature (High Temp)	12
4.3.1	Inlet temperature (IT)	12
4.3.2	Room temperature (RT)	12
5	Airlinq®	14
6	Airlinq Viva control panel	15
6.1	Automatic operating lock	16
6.2	Child lock	16
6.3	Start	16
6.3.1	Automatic operation	16
6.3.2	Start or restart automatic operation	16
6.3.3	Start operation manually	17
6.4	Standby	17
6.5	Switch off the unit	18
6.6	Air flow - manual setting	18
6.7	Holiday mode	19
6.7.1	Activate holiday mode	20
6.7.2	Deactivate holiday mode	20
6.8	Warnings and alarms	20
6.8.1	Light signals for warnings and alarms	20
6.8.2	Warning (yellow)	21
6.8.2.1	Slow flash and Rapid flash	21
6.8.2.2	Rapid double flash at 2 second intervals	21

6.8.2.3	Light on constantly	21
6.8.3	Alarm (red)	21
6.8.3.1	Slow flash	21
6.8.3.2	Rapid flash.....	21
6.8.3.3	Rapid double flash at 2 second intervals	22
6.8.3.4	Light on constantly.....	22
7	Airlinq Orbit control panel.....	23
7.1	Automatic operating lock.....	24
7.1.1	Activate operation.....	24
7.2	Air flow - manual setting.....	24
7.3	Automatic operation	25
7.4	Operating menu	26
7.4.1	Start and Standby.....	26
7.4.1.1	Start or restart automatic operation	26
7.4.1.2	Start operation manually.....	26
7.4.1.3	Standby	26
7.4.2	Off.....	27
7.4.3	Holiday Mode	27
7.4.3.1	Activate holiday mode.....	27
7.4.3.2	Deactivate holiday mode	27
7.4.4	Status	28
7.4.5	Setup.....	31
7.4.5.1	Timers.....	31
7.4.5.1.1	Adjust or add a program	32
7.4.5.1.2	Activate a program.....	32
7.4.5.1.3	Deactivate a program.....	32
7.4.5.1.4	Remove a program	32
7.4.5.2	Date and Time	33
7.4.5.3	Default flow.....	33
7.4.5.4	Default temp	33
7.4.5.5	High temperature.....	34
7.4.5.6	Reset service.....	34
7.4.5.7	Data Log	34
7.4.5.8	Startup Guide	34
7.4.6	Lock screen	35
7.4.6.1	Activate screen lock.....	35
7.4.6.2	Deactivate screen lock.....	35
7.5	Indoor climate level	36
7.6	Airlinq BMS	36
7.6.1	Control and settings.....	37
7.6.1.1	Select a Group/Unit	37
7.6.1.2	Start.....	38
7.6.1.2.1	Start or restart automatic operation for a group/several groups.....	38

7.6.1.2.2	Start operation manually	38
7.6.1.3	Standby	38
7.6.1.4	Switch Off	38
7.6.1.4.1	Switch off a group/several groups.....	38
7.6.1.4.2	Switch off system.....	38
7.7	Warnings and alarms	39
7.7.1	Warnings (yellow triangle)	39
7.7.2	Alarms (red triangle).....	40
8	Airlinq® Online.....	41
8.1	Login.....	41
9	Service and maintenance.....	42
9.1	External cleaning	42
9.2	Internal cleaning.....	42
9.3	Cleaning the condensate system	42
9.4	Filter change	43
9.4.1	AM 950 C filter location	44
9.4.1.1	Filter change.....	46
9.4.2	AM 950 F filter location.....	49
9.4.2.1	Filter change.....	49
9.4.3	Reset service (filter change).....	51
9.4.4	Filters.....	51
9.5	Smoke detector, AM 950 C.....	52
9.6	Smoke detector, AM 950 F	52
9.7	Setting the inlet air grille.....	53
9.7.1	Inlet air grill location.....	53
10	Error description	55
11	Repairs and improvements.....	56
12	Dismounting.....	56
13	Disassembly	56
14	Disposal.....	56
Appendix A	EU Declaration of Conformity	57

1 Function principle

The diagram below shows the basic function of an Airmaster air handling unit:

Bypass: Fresh air side

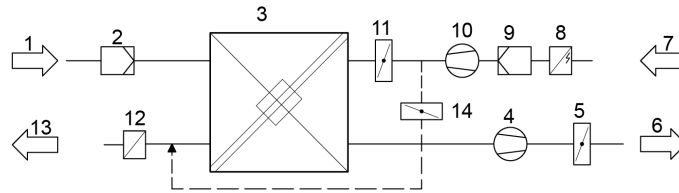

Bypass: Exhaust air side

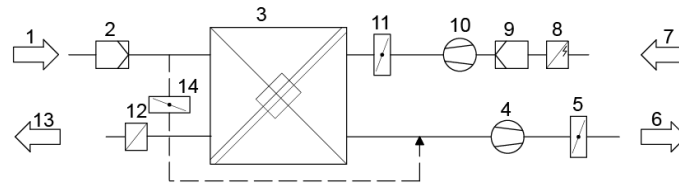

1. Extract air (waste air from the room).
2. Extract air filter.
3. Counter-current heat exchanger(s): heat exchangers effectively transfer heat energy from the extract air to the inlet air.
4. Extract air fan.
5. Motorized exhaust air damper: shuts off the extract air path when the unit is stopped.
6. Exhaust air.
7. Supply air (fresh air from outside)
8. Preheating surface (option): supports the de-icing function.
9. Supply air filter.
10. Supply air fan.
11. Motorized supply air damper: shuts off the supply air path when the unit is stopped.
12. Comfort heater (option): equalizes the minor temperature loss in the heat exchanger (pos. 3).
13. Inlet (supply of heated outside air).
14. Modulating bypass: the bypass damper is used to regulate the inlet air temperature.

The air temperature is monitored in the unit before and after the heat exchanger in the extract air path and the supply air path.

2 LED Signals

The AME 900 F is equipped with a LED in the input opening to show the operation status. The LED also shows warnings and alarms.

Individual signal types:

_ : LED is off (intervals of whole seconds).

I : LED is on (intervals of whole seconds).

Signals with priority 1 to 6:

Pri.	Signal	Off/On time	Meaning
1	_ I I _ I _ I _ _ _ _ I _ I _ I	Off 1 s and on 1 s, 4 times; pause 5 s; repeat	Buzz alarm without filter alarm
2	_ I _ I _ I _ _ _ _ I _ I _ I	Off 1 s and on 1 s, 3 times; pause 5 s; repeat	Filter alarm
3	_ I _ I _ _ _ _ I _ I	Off 1 s and on 1 s, 2 times; pause 5 s; repeat	Buzz warning without filter warning
4	_ I _ _ _ _ _ I	Off 1 s and on 1 s; pause 5 s; repeat	Filter warning
5		Light constantly on	Operation without warning or alarm (Option)
6	_ _ _ _ _ _ _ _	LED off	Operation without warning or alarm, No operation, warning or alarm

The highest active priority is shown within the programmed period of time (default: 07:00 to 22:00). The signal for priority 5 ("Operation without warning or alarm") can be deactivated.

2.1 Buzz warning

Buzz warning without filter warning (priority 3) includes the following warnings:

- Technical errors in the temperature sensors (RT, OTV, OT, EVi, EVo or HG) or CO₂ sensor. In case of errors OT, EVi, EVo or HG, the cooling module is out of order. Certain internal control system functions are working insufficiently if faults RT and OTV occur.

→ **Call service.**

2.2 Buzz alarm

Buzz alarm without filter alarm (priority 1) includes the following alarms:

- Low temperature alarm
- Condensate in air handling unit
- Technical fault in a temperature sensor (IT, ETV) or a fan.

→ **Call service.**

See also section 7.7 Warnings and alarms on page 39.

3 Control functions

3.1 Timer-controlled ventilation

This function controls the AME 900 F unit fully automatically according to a timer using an integrated clock. Timer-controlled ventilation can be set using the control panel menu or Airlinq User Tool.

This function has 7 independent programs available. Day, start and stop times, air flow and inlet temperature can all be individually set for all programs.

3.2 Night time cooling

Night time cooling starts and stops the air handling unit using the integrated timer. The function starts the air handling unit even if it has not been in operation if the temperature parameters are fulfilled.

The night time cooling function is active as standard. Settings can be made using the control panel menu, Airlinq User Tool or Airlinq Service Tool.

It can be used to reduce the room temperature (RT) during the night, if the temperature has exceeded the nominal values "NC High" (if night time cooling was not active the previous night), or "NC Low" (if night time cooling was active the previous night) in the daytime.

It works with a parameter setting (high air flow and low inlet temperature) optimized to cool down the contents of the room and the building to limit room temperature during the day.

If the air handling unit has a cooling module and bypass damper, the inlet temperature (IT) can be regulated.

Standard settings:

- Start time: 00:00
- Stop time: 06:00
- Air flow: Boost
- Inlet temperature: 14°C
- Temperature upper limit "NC High": 26°C
- Temperature lower limit "NC Low": 23°C
- Activation status: active

3.3 Holiday mode

Holiday mode is used as basic ventilation when the room is unused for an extended period, e.g. holidays. In holiday mode, Airlinq will run the unit with min. air flow.

The internal control function "Low Temperature" is active to protect the unit against ice formation. The control function is able to activate the heating surfaces if necessary.

The internal control function "High Temperature" is deactivated in holiday mode.

See section 4 Internal control functions on page 12.

3.4 Start and stop using external contacts

It can be necessary to start or stop the unit automatically using an external contact. The start and stop functions via external contact can also be used when the unit is running e.g. basic ventilation. This gives the user the option of switching the unit into another mode and back again.

3.4.1 Built-in smoke detector

If the unit has a built-in smoke detector the smoke detector functions as an external start/stop, hence the unit will stop if the smoke detector is activated. In this case, the smoke detector must be reset before the unit can start again.

Resetting the smoke detector is described in the smoke detector manual, see the Oppermann manual which is part of the delivery.

3.5 Start and stop using a PIR sensor

The unit is set to start/stop via a signal from a PIR (motion) sensor. When a signal is received from the PIR sensor because of movement in the sensor's detection field, the unit will start at the standard air flow set (default flow) and inlet temperature (default temp).

When the signal ceases, the unit will stop once an after-run time has elapsed (factory set to 30 min).

The factory set parameters can be changed, and the PIR sensor can be deactivated using Airlinq Service Tool.

3.6 Control using a CO₂ sensor

A CO₂ sensor is used to control the air handling unit independent of the strain on the room's indoor climate. You can choose whether to let the air flow be controlled by the sensor, see section 3.6.1, or let the system's entire operation be controlled by the sensor, see section 3.6.2.

3.6.1 Air flow control

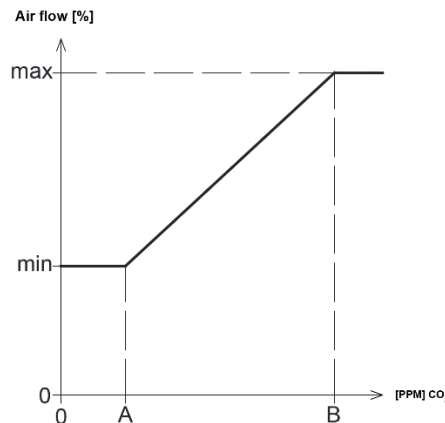

The unit can be set to run with a reduced basic air volume (min.) for basic ventilation. If the CO₂ concentration in the room exceeds the programmed lower limit value (A), the sensor will take over and increase the air handling unit's air flow. If the CO₂ concentration in the room continues to rise, the air flow is linearly increased to the maximum air flow (max.) at the indoor climate level's upper limit value (B) and above.

For measurements between the lower and upper limit values, the air flow is fully automatically increased and reduced between the basic air flow and the maximum air flow.

If the CO₂ concentration returns to the programmed lower limit value (A) or below, the air handling unit will return to running on the basic air flow.

To use this function, the timer flow or the default flow has to be reduced. See section 7.4.5.1 Timers on page 31 and section 7.4.5.3 Default flow on page 33.

3.6.2 Start, stop and air flow control

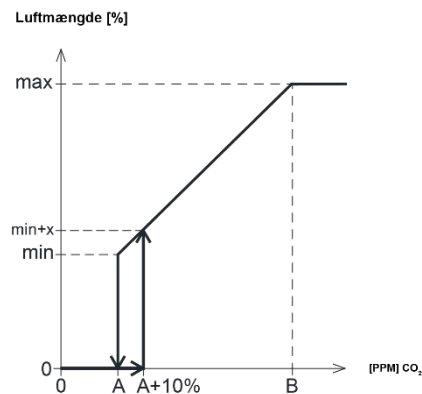

If the air handling unit is completely controlled by the sensor, it will start at slightly above the standard air flow (min. + x) when the CO₂ concentration exceeds the programmed lower limit value plus 10 % (A+10%).

If the CO₂ concentration in the room continues to rise, the air flow is linearly increased to the maximum air flow (max.) at the indoor climate level's upper limit value (B) and above.

For measurements between the lower and upper limit values, the air flow is fully automatically increased and reduced between the basic air flow and the maximum air flow.

If the CO₂ concentration falls below the programmed lower limit value (A), the air handling unit will stop.

To use this function, the CO₂ sensor has to be programmed as a start parameter using the "Startup guide", Airlinq User Tool or Airlinq Service Tool.

Factory settings:

- Lower limit A: 500 ppm (CO₂ Min)
- Upper limit B: 900 ppm (CO₂ Max)
- min: 30 % (Standard air flow)
- max: 100% (Max. airflow)
- Start Priority 7: CO₂

Settings can be made using the control panel menu points "Default flow" (see page 33) and "Startup Guide" (see page 34), Airlinq User Tool or Airlinq Service Tool.

3.7 Boost

The boost function can adjust the airflow temporarily and is programmed to use some fixed control voltages for the supply air fan and the extract air fan respectively. It is possible to adjust the control voltages for the fans independently of each other if unbalanced ventilation is required.

The function is activated by an external switch that is connected to an input terminal at the main box.

The air handling unit stops the normal operation and activates the boost function when the contact closes. If the signal is disrupted, the unit will return to the previous operating mode (after-run time is factory set to 0 min). In case the air handling unit is stopped the boost function will start it.

3.8 Control using an analogue BMS

An air handling unit can be controlled using an A-BMS (analogue Building Management System), which can start and stop the unit, and regulate air flow and inlet temperature.

The A-BMS can be fitted with an alarm signal (alarm contact) from the air handling unit, when the unit registers an internal alarm. The A-BMS will start the unit using a start/stop signal and then control air flow and inlet temperature.

It is also possible to start and stop the unit using an A-BMS and then operate and set it using the control panel

4 Internal control functions

Internal control functions run automatically, and influence air flow and inlet temperature. An internal control function is shown under control panel menu point “Status”, or using the Airlinq User Tool or Airlinq Service Tool.

4.1 Low temperature (Low Temp)

The “Low Temperature” internal control function protects the heat exchanger against ice forming at low outside temperatures, and maintains the inlet temperature (IT) when the temperature conditions are too low for the standard parameters.

The control function increases the inlet temperature (IT) independently and/or protects the heat exchanger by reducing the supply air and increasing the extract air. It thus creates unbalanced ventilation. It runs regardless of whether the unit has heating surfaces or not.

If the unit is fitted with preheater and comfort heater, the control system can maintain balanced operation even at very low temperatures.

The control system function starts automatically when:

1. The inlet temperature (IT) falls 2 °C below the inlet temperature setpoint
or
2. If there is a risk of ice forming on the heat exchanger.

4.2 Preheat

The Preheat internal control function ensures unit operation at low outside temperatures, when the unit has an electric preheater surface.

The control system switches on the heater automatically as required. The heating surface will heat up the cold supply air before it reaches the heat exchanger, preventing ice forming on the heat exchanger.

4.3 High temperature (High Temp)

“High Temperature” automatically reduces the inlet temperature (IT) or the room temperature (RT) to a limited extent if necessary. The internal control function requires that the unit is fitted with a bypass damper.

4.3.1 Inlet temperature (IT)

The control function gradually opens the bypass damper if the inlet temperature (IT) rises 2 °C above the setpoint. When the bypass damper opens, some of the air is directed past the heat exchanger. This reduces supply air heating.

4.3.2 Room temperature (RT)

High room temperature is preprogrammed at 25°C. At this temperature, the upper limit of the temperature range described as “comfort temperature” is exceeded.

When the room temperature (RT) exceeds the setpoint, the inlet air temperature (IT) is reduced automatically, as the unit will attempt to lower the room temperature to the configured setpoint.

Setpoint is set using the control panel menu point “High Temperature” (see page 34) or a PC running Airlinq User Tool or Airlinq Service Tool.

To ensure trouble-free operation, we recommend programming high room temperature higher than the normal room temperature.

The control function can regulate the inlet temperature (IT). Similarly, the control system can increase air flow to 100%, if the inlet temperature is at least 5°C under the room temperature. The control function is active until the room temperature (RT) falls 1 °C under the programmed limit "High temperature".

5 Airlinq®

Airmaster focuses not only on the air handling unit, but also on the control system software and operation. Airlinq is Airmaster's own unique ventilation control system, which gives the user and service technician impressive overview and full control over the indoor climate, plus easy access to a host of functions, which ensure correct operation of Airmaster air handling units.

Airlinq consists of a self-explanatory, intuitive control panel, Airlinq Viva (white) or Airlinq Orbit (black) and an integrated control box (AQC L), designed to control all functions and equipment in the air handling unit supplied.

The system can be connected to a PC using Airmaster programs "Airlinq User Tool" (corresponds to operating with Airlinq Orbit) for comfortable operation, or "Airlinq Service Tool" (only for service technicians) for programming and maintenance.

Airlinq's primary functions are:

- Controlling air flow and inlet temperature.
- Manual control.
- Timer-controlled operation using a timer.
- Unrestricted night time cooling for reducing room temperature during the night.
- Programmed operation using sensors (e.g. carbon dioxide (CO₂) sensors), analogue (A-BMS) and digital Building Management System (D-BMS).
- De-icing function and control of preheating surface and comfort heater for unit operation at low outside temperatures.
- Monitoring of the unit's temperature, components and air flow.
- Alarm functions for maintenance or fault.
- Control of up to 20 individual air handling units via a single control panel in an Airlinq BMS system, with sensors connected as required.
- Continuous and timed data log, which can be transferred to PC.
- PC connection to the Airlinq Viva and the Airlinq Orbit control panel or to the control unit (AQC).

6 Airlinq Viva control panel

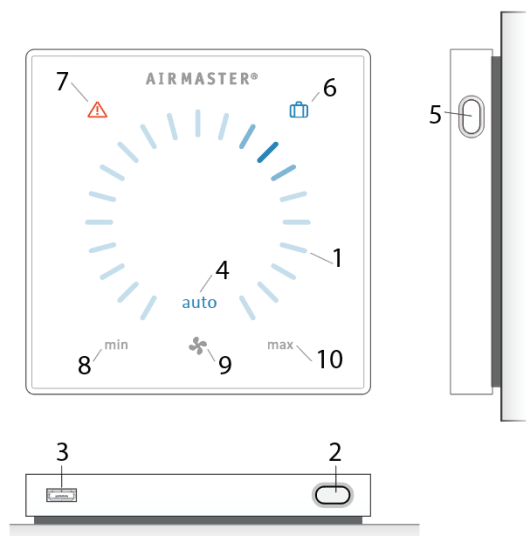

1. Air flow setting (blue light) using a touch sensitive control area.
2. Function button (manual start, manual stop, manual temporary stop).
3. USB mini-B port. To set or programme the air handling unit, a PC is connected with "Airlinq User Tool" or "Airlinq Service Tool" loaded.
4. Symbol "auto" for automatic operation (blue).
5. Holiday mode button.
6. Symbol for holiday mode (blue).
7. Symbol for warnings (yellow) and alarms (red).
8. Text "min" for minimal air flow.
9. Fan symbol.
10. Text "max" for maximum air flow.

Touch screen:

The Airlinq® Viva control panel is fitted with a touch screen operated in the same way as a smartphone. The control surface is 52 x 52 mm. To change the display view, scroll on either the left or right side of the control surface.

Screen displays and symbols adapt menus and functions automatically.

6.1 Automatic operating lock

The control panel is fitted with an automatic operating lock to prevent accidental air flow setting, e.g. during cleaning. The lock activates automatically after 30 seconds of no operation.

Cancel automatic operating lock:

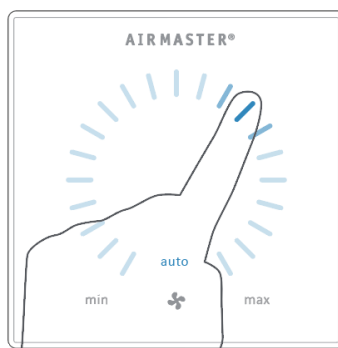

Press for 1 second on the current air flow.

The automatic operating lock will cancel when the air flow display is marked up to the current setting by blue stripes.

6.2 Child lock

The child lock prevents all operation. If you try to operate the panel with an active child lock it will trigger all the blue stripes on the display to flash twice.

Activate or cancel the child lock:

Press "Function button" and "Holiday mode button" (Pos. 2 and 5) simultaneously for 4 seconds.

>> All blue stripes on the air flow display will flash twice.

6.3 Start

The air handling unit can be started and stopped automatically or using the function button.

6.3.1 Automatic operation

Automatic operation is started using a timer, night time cooling, sensors, external contacts or an analogue BMS system. The current air flow and text "auto" are shown on the control panel with a blue light above the fan symbol.

Air flow can be over- or overridden manually, see section 6.6. If this is done, automatic operation is cancelled and the text "auto" will disappear.

6.3.2 Start or restart automatic operation

Press the function button. (Pos. 2)



>> The unit will start according to its programming if a start signal is active. The control system will reactivate automatic operation after manual override. The current air flow will be shown by a blue stripe. "Auto" will be shown with a blue light.

6.3.3 Start operation manually

Double press the function button (Pos. 2).

>> The unit will start with standard air flow and standard inlet air temperature (see page 19). "Auto" will be shown with a blue light.

After 4 hours (time can be adjusted to 0, 1, 2, ... 255 hours using a PC with Airlinq Service Tool loaded) the unit will return to automatic operation.

6.4 Standby

Press the function button (Pos. 2) when the unit is in operation.

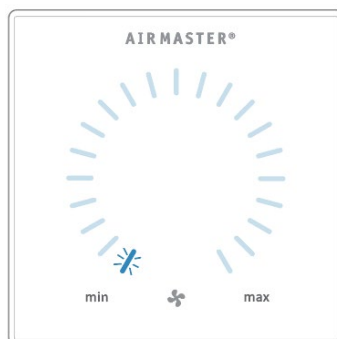

>> The unit will stop for 1 hour (time can be adjusted to 0, 1, 2, ... 255 hours using a PC with Airlinq Service Tool loaded) and then start at the next start signal.

Otherwise, the unit can be started earlier by using the function button. The air flow indicator will flash slowly alongside minimum.

6.5 Switch off the unit

Press the function button (Pos. 2) for min. 2 seconds to switch off the unit.



>> The unit must be started using the function button. All lights on the control panel will go out.

6.6 Air flow - manual setting

Cancel the operation lock or screen lock (if in use) and press the current air flow until the air flow display is marked up to the current setting with blue stripes.

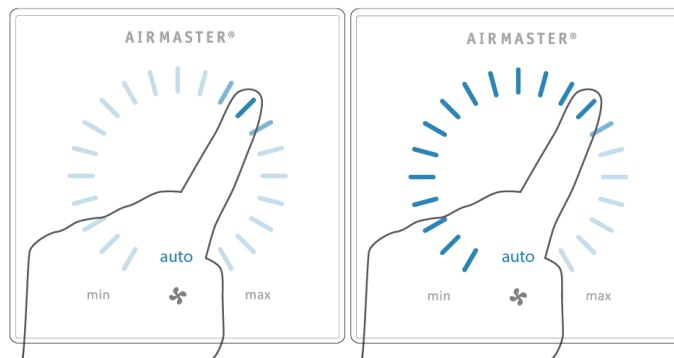

Drag your finger on the setting area clockwise to increase air flow or counter clockwise to reduce air flow. The light will follow your movement.

Lift your finger from the screen when the required air flow is shown. The current setting will be shown with a single blue stripe.



After 12 hours (time can be adjusted to 0, 1, 2, ... 255 hours using a PC running Airlinq Service Tool) the unit will return to automatic operation.

The same setting can be made by pressing the required air flow if the automatic operating lock is not active.

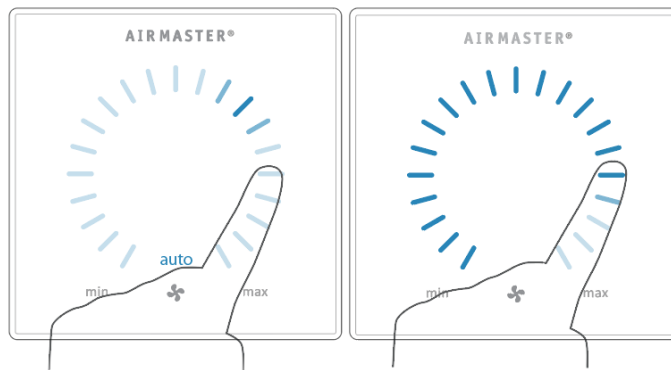

Lift finger from the area when the required air flow is shown. The current setting will be shown with a single blue stripe.

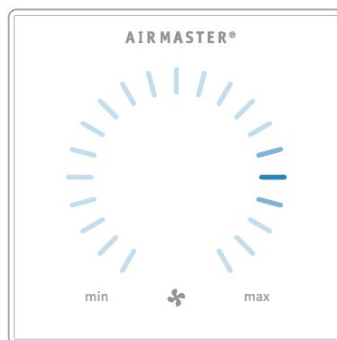

6.7 Holiday mode

Holiday mode is used as basic ventilation when the room is unused for an extended period, e.g. during holidays.

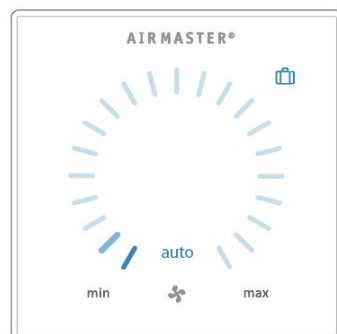

In holiday mode, the unit will run with min. air flow. The internal control function “Low temperature” is active to protect the unit against ice formation.

The control function is able to activate the heating surfaces if necessary. The internal control function “High temperature” is deactivated in holiday mode.

See also section 4 Internal control functions on page 12.

6.7.1 Activate holiday mode

Press holiday mode button (pos. 5) for 2 seconds.

>> The unit will go into holiday mode.

6.7.2 Deactivate holiday mode

Press the function button (pos. 2).

>> The unit will return to automatic operation.

6.8 Warnings and alarms

The Airlinq control system monitors temperatures, airflow, cooling module function, filter status, and various components.

In the event of a fault, the control panel will show a yellow or red symbol. The unit will maintain operation for yellow warnings if possible, whilst it will stop for red alarms.

Warnings and alarms are shown by flashes at various intervals or a constant light. In the event of multiple faults, the faults will be shown with a brief pause in between each one.

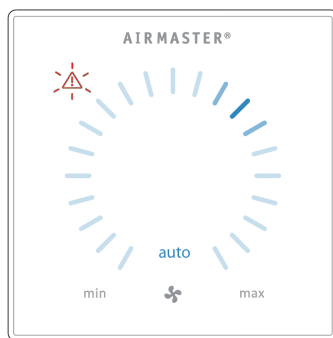

Alarm (red)



Warning (yellow)

6.8.1 Light signals for warnings and alarms

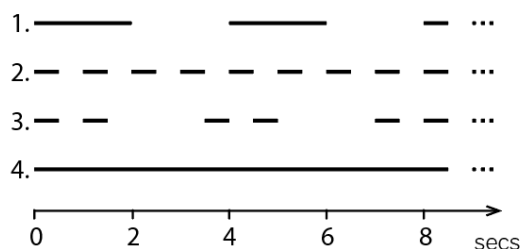

1. Slow flash (2 seconds on 2 seconds off).
2. Rapid flash (0.5 seconds on, 0.5 seconds off).
3. Rapid double flash (0.5 seconds on, 0.5 seconds off, 0.5 seconds on) at 2 second intervals.
4. Light on constantly.

See explanation of fault types on next page.

6.8.2 Warning (yellow)

The air handling unit remains in operation in the event of a warning, but can deviate from standard operation.

6.8.2.1 Slow flash and Rapid flash

These warnings are not applicable for the AM 950 units.

6.8.2.2 Rapid double flash at 2 second intervals

Filter needs replacing. Operation will continue unchanged. Change filters and reset service (see below) or call service.

Press Reset Service.

>> Enter the code (Standard "9732") and confirm.

6.8.2.3 Light on constantly

Technical fault on temperature sensors (RT, OTV, OT, EVi, EVo or HG), flow control or CO₂ sensor. Certain internal control functions are working insufficiently if faults RT and OTV occur.

CALL SERVICE.

6.8.3 Alarm (red)

The unit will stop to prevent damage in the event of an alarm.

6.8.3.1 Slow flash

Low temperature - Low outside temperatures can make it necessary to protect the unit against ice formation. In such instances, the low temperature alarm will activate.

The unit will automatically try to start up once every hour if the start signal is still active.

6.8.3.2 Rapid flash

Condensate - There is condensate in the unit which has not been automatically removed. Remove condensate manually from the condensate tray.

Units with no condensate drain: If the alarm repeats, it may be necessary to install a condensate drain or pump. Call service.

Units with condensate drain/pump:

Clean the condensate system (see page 30), or call service.

The water lock is wrongly fitted. Installation can be corrected by authorized experts.

Condensate pump defective. Call service.

6.8.3.3 Rapid double flash at 2 second intervals

Filter needs replacing. Replace filters and reset service (see below) or call service.

Press Reset Service.

>> Enter the code (Standard "9732") and confirm.

6.8.3.4 Light on constantly

Critical fault on temperature sensors (IT, ETV) or a fan.

CALL SERVICE.

7 Airlinq Orbit control panel

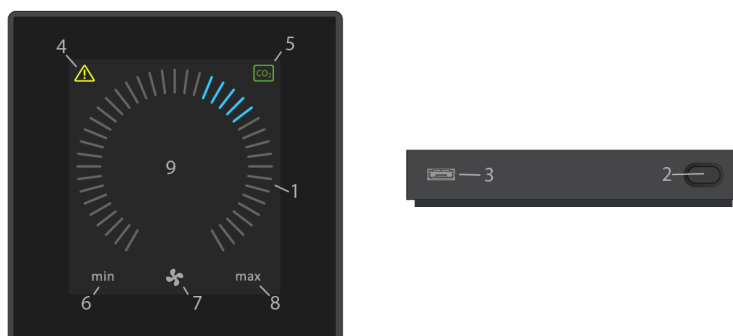

1. Air flow setting (blue stripes).
2. Function button (activate control menu, switch off unit).
3. USB mini-B port. Connection to PC using "Airlinq Service Tool", to program the air handling unit.
Download "Airlinq Service Tool" at: www.airling.eu
4. Symbol for warnings (yellow) and alarms (red).
5. CO₂ symbol.
6. Text "min" for minimal air flow.
7. Fan symbol.
8. Text "max" for maximum air flow.
9. Touch screen.

Other symbols:

	"Auto"
	"Start"
	"Standby"
	"Switch off"
	"Confirm"
	"Back"
	"Cancel"
	"Help"
	"Selectable"
	"Selected"
	Value "Increase"
	Value "Reduce"
	"Holiday mode" symbol shows for holiday mode instead of fan symbol
	Padlock is displayed when the unit is operated with active automatic operating lock and active screen lock
	"Automatic operation" text off when manual override or underride activated for air flow
	"Status"
	"Timer-controlled ventilation"
	"Night time cooling"
	"Setup"

Touch screen:

The Airlinq Orbit control panel is fitted with a touch screen operated in the same way as a smartphone. The control surface is 52 x 52 mm. To change the display view, scroll on either the left or right side of the control surface.

Screen displays and symbols adapt menus and functions automatically.

7.1 Automatic operating lock

The control panel is fitted with an automatic operation lock to prevent accidental operation, e.g. caused by cleaning.

The lock activates automatically after 120 seconds of no operation. The screen shows a padlock symbol with a directional arrow at the bottom if operated.

7.1.1 Activate operation

Press padlock and drag in direction of arrow.



To lock the screen against accidental operation, see section 7.4.6 Lock screen on page 35.

7.2 Air flow - manual setting

Cancel the operation lock or screen lock (if in use) and press the current air flow until the air flow display is marked up to the current setting with blue stripes.

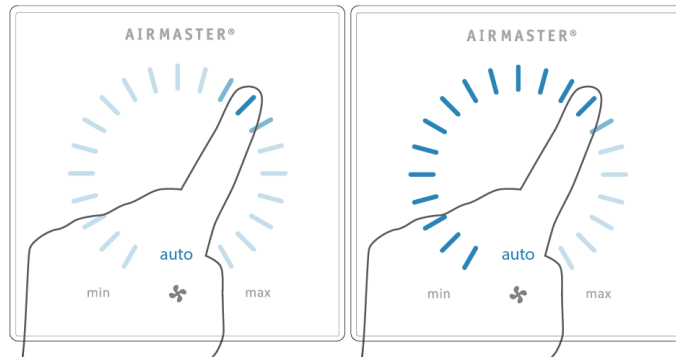

Drag your finger on the setting area clockwise to increase air flow or counter clockwise to reduce air flow. The light will follow your movement.

Lift your finger from the screen when the required air flow is shown. The current setting will then be shown with 5 blue stripes.



After 12 hours (time can be adjusted to 0, 1, 2, ... 255 hours using a PC running Airlinq Service Tool) the unit will return to automatic operation.

The same setting can be made by pressing the required air flow until the air flow display is marked up to the required setting with blue stripes.

Lift finger from the area when the required air flow is shown. The current setting will then be shown with 5 blue stripes.

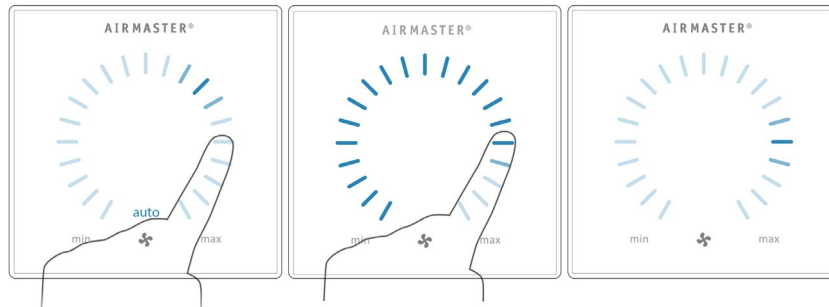

7.3 Automatic operation

Automatic operation is started using a timer, night time cooling, sensors, external contacts or an analogue BMS system.

The current air flow and text “auto” are shown on the control panel with a blue light above the fan symbol. See also section 3 Control functions on page 8.

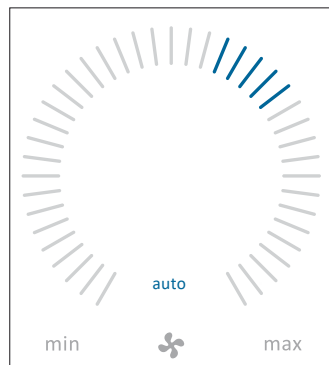

Air flow can be over- or overridden manually. Automatic operation is cancelled and the text “auto” will disappear.

7.4 Operating menu

Start the operating menu by pressing the function button (pos. 2 in section 7 Airlinq Orbit control panel on page 23).

Press a menu point to open the menu or activate/cancel a function.

Depending on the menu, related function fields will also be changed. These can include text fields such as “Confirm”, “Switch off”, “Cancel” or fields with symbols. Pop-up texts can also appear for certain menus.

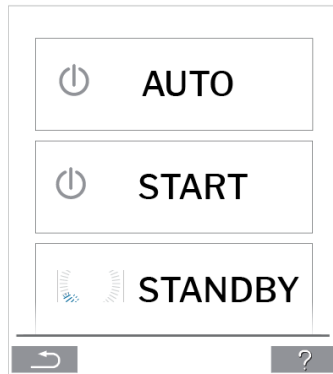

For group operation, see section 7.6 Airlinq BMS on page 36.

7.4.1 Start and Standby

7.4.1.1 Start or restart automatic operation

Press menu field “ AUTO”.

>> The unit will start according to its programming if a start signal is active, or automatic operation will be reactivated after manual override. The current air flow will show with 5 blue stripes. Text “auto” will show with blue light.

7.4.1.2 Start operation manually

Press menu field “ START”.

>> The unit will start with standard air flow and standard inlet air temperature (see page 19). Text “auto” will show with blue light. After 4 hours (time can be adjusted to 0, 1, 2, ... 255 hours using a PC running Airlinq Service Tool) the unit will return to automatic operation.

7.4.1.3 Standby

Press menu field “ STANDBY” if the unit is in operation.

>> The unit will stop for 1 hour (time can be adjusted to 0, 1, 2, ... 255 hours using a PC running Airlinq Service Tool) and then start at the next start signal.

The air flow indicator will flash slowly alongside minimum.

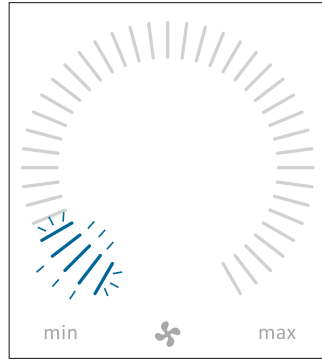

The unit can be started earlier by using the operating menu.

7.4.2 Off

Press menu field “ OFF”.

>>The control panel will show “SHUTDOWN? AFTERWARDS THE SYSTEM HAS TO BE STARTED MANUALLY”.

>> Press the tick to switch off or the cross to cancel switching off.

You can also press the function button for 2 seconds (pos. 2 in section 7 Airlinq Orbit control panel on page 23).

The unit must be started according to section 7.4.1 Start and Standby on page 26.

7.4.3 Holiday Mode

In holiday mode, the air handling unit will run with min. air flow.

The internal control function “Low temperature” is active to protect the unit against ice formation. The control function is able to activate the heating surfaces if necessary. The internal control function “High temperature” is deactivated in holiday mode.

See also section 4 Internal control functions on page 12.

7.4.3.1 Activate holiday mode

Press menu field “ HOLIDAY MODE”.

>> Holiday mode will activate. The holiday mode symbol will show instead of the fan symbol.

7.4.3.2 Deactivate holiday mode

To deactivate holiday mode, the unit must be started according to section 7.4.1 Start and Standby on page 26.

7.4.4 Status

The Status menu is divided into 6 groups: Information, Flow, Filters, Operation, Hardware, and Installation Check. The menu points indicate the unit's operational status.

Press menu field "i STATUS".

>> The sub-menu will activate. Press the required sub-menu.

Information	Total Operation time	The unit's operation hours since manufacture
	Panel SW	Control panel software version
	Control unit SW	Control unit software version
	Control unit Serial	Control unit serial number
	Service	Contact address for technical help and service. Can be changed using Airlinq Service Tool.

Flow	Requested Flow	Air flow in %
	Supply Air Flow	Supply air flow in m ³ /h
	Extract Air Flow	Extract air flow in m ³ /h
	Supply Air Fan	Supply air fan RPM
	Extract Air Fan	Extract air fan RPM

Filters	Current filter state	Filter status indicator in %
	Operation since service	Number of operation hours since last filter change
	Next service	Forecast of hours to next filter change
	Approximated date	Forecast (date) of next filter change

Operation	Started By	<p>Operation start signal:</p> <ul style="list-style-type: none"> • “External”, using external contacts and relays • “Airlinq”, manual start using a control panel • “CO₂”, using a CO₂ sensor • “PIR”, using a passive infrared sensor • “BMS”, using an analogue or digital BMS system • “Timer”, using a timer • “Holiday mode”, via control panel or a digital BMS system • “Dependent”, on several start signals
	Operation State	<p>Operation status:</p> <ul style="list-style-type: none"> • “Automatic”, fully automatic operation according to programming • “Manual”, when the automatically set air flow or inlet temperature is changed by the user or a BMS system • “Night time cooling” is activated • “Holiday mode” is activated • “OFF”, the unit is switched off, and must be started using the control panel • “Standby”, the unit is temporarily stopped and will start automatically according to programming
	System Condition	<p>Active internal control system function:</p> <ul style="list-style-type: none"> • “Low temperature” • “High temperature” <p>See section Internal control functions on page 12</p>
	External Stop	Stop function status On/Off
	Inlet Temperature	Inlet temperature in °C
	Outside Temp. AHU	Outside temperature air handling unit in °C
	Room Temperature	Extraction temperature in °C
	Exhaust Temp. AHU	Exhaust temperature air handling unit in °C
	Requested Temp.	Setpoint Inlet temperature in °C
	Max Room Temp.	Setpoint “High room temperature” in °C
	Pre Heater	Connected in %
	Comfort Heater	Connected in %
	Main Damper	Status On/Off
	Bypass Damper	Bypass position in %. (0 = closed; 100 = fully open)
	Adaptive Airflow	Signal voltage Adaptiv Airflow® in Volts
	Supply Air Fan	Signal voltage supply air fan in Volts
	Extract Air Fan	Signal voltage extract air fan in Volts
	Cooling Module	Operation in %
	Evaporator temp.	Evaporator temperature in °C
	Condenser temp.	Condenser temperature in °C
	Setpoint Cooling Mod.	Cooling module temperature setpoint in °C
	Outside Temperature	Outside temperature cooling module in °C
	Evaporator in	Evaporator temperature “in” in °C
	Evaporator out	Evaporator temperature “out” in °C
	Hot Gas	Hot Gas temperature in °C
	Rel. humidity outside	Relative humidity (outside air) in %
	Rel. humidity inside	Relative humidity (exhaust air) in %
	AI#1	Analog input 1 in Volts
AI#2	Analog input 2 in Volts	
AI#3	Analog input 3 in Volts	

The status menu will not show any value if an option is not installed.

Hardware	The condition of the individual components are monitored and displayed in this menu. Component functional = "OK" Component with fault = "Fault" Component not programmed = "N/A"	
	Components monitored:	
	Room temperature	Room temperature sensor
	Inlet temperature	Inlet temperature sensor
	Outside temperature	Outside temperature sensor
	General.Purp.Temp.	General purpose temperature sensor
	Condenser Temp.	Condenser temperature sensor
	Evaporator Temp.	Evaporator temperature sensor
	Exhaust Temp. AHU	Exhaust temperature sensor air handling unit
	Outside Temp. AHU	Outside temperature sensor air handling unit
	Supply Air Flow Sens. 1	Supply air flow sensor 1
	Supply Air Flow Sens. 2	Supply air flow sensor 2
	Extract Air Flow Sensor	Extract air flow sensor
	CO ₂ Sensor	CO ₂ Sensor
	Supply Air Fan	Supply air fan
	Extract Air Fan	Extract air fan
	Evaporator In Temp.	Evaporator inlet temperature sensor
	Evaporator Out Temp.	Evaporator outlet temperature sensor
	Hot Gas Temperature	Hot gas temperature sensor
	CC Connection	Data connection to the cooling module
CC Stepdriver	Step driver cooling module	
CC Frequency Inverter	Frequency inverter cooling module	
Humidity Sensor (out)	Humidity Sensor (outside)	
Humidity Sensor (in)	Humidity Sensor (inside)	



Installation Check	All units in the Airlinq system are identified and shown in the order it is programmed. The Installation check will show the following:	
	This Unit	Type of unit that shows the "Installation check"; PC or ID number of the control panel
	Expected AHU's	Number of air handling units expected in the system
	Online AHU's(*)	Number of online air handling units

(*)Sub-menu "Online AHU'S"	
Group "x", ID "y"	All groups complete with air handling unit ID (ID = identification number): x = 0, 1, 2, ... or 19, y = 0, 1, 2, ... or 19. If cooling modules are installed the text "+CC ID" is shown together with the identification number of the cooling module; 100, 101, 102, ... or 119
(*)Sub-menu "Online Control Panels"	
ID "z"	Identification number of all online control panels: z = 160, 161, 162, ... or 179
(*)Sub-menu "Group Master N/A"	
Group "x", ID "y"	See description above

7.4.5 Setup

All operational parameters can be changed under the “setup” menu.

7.4.5.1 Timers

 TIMER-CONTROLLED VENTILATION and  NIGHT TIME COOLING which is set using the control panel or “Airing User Tool” starts and stops the air handling unit using a timer. There are up to 7 different timer programs for timer-controlled ventilation. All programs can be active concurrently, and run after each other or override each other.

Program display:

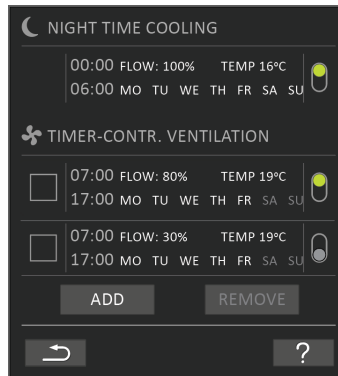

Examples of programs displayed:

Night time cooling:

- Air flow (Flow) 100%
- Inlet temperature (Temp) 16 °C
- Start: 00:00, Stop: 06:00
- Days: All days of the week (MO, TU, ..., SA, SU)
- Program active (green point).

Days for night time cooling cannot be adjusted.

Timer-controlled ventilation program, upper part:

- Air flow (Flow) 80%
- Inlet temperature (Temp) 19 °C
- Start: 07:00, Stop: 17:00
- Days: Monday to Friday (MO, TU, WE, TH, FR shown in white text); Saturday and Sunday are programmed inactive (SA and SU shown in light grey text)
- Program active (green point).

Timer-controlled ventilation program, lower part:

- Air flow (Flow) 30%
- Inlet temperature (Temp) 19 °C
- Start: 07:00, Stop: 17:00
- Days: Monday to Friday (MO, TU, WE, TH, FR shown in white text), Saturday and Sunday are programmed inactive (SA and SU shown in light grey text)
- Program inactive (grey point).

7.4.5.1.1 Adjust or add a program

Press the program to adjust it or press “Add” to add a program.

The “Setting” mode will start.

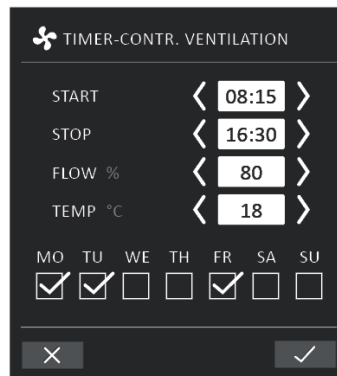

Increase/reduce a value:

Values can be set by pressing the right arrow (increase) or left arrow (reduce). Operation days are marked with a tick.

Make all settings and confirm by pressing the tick.

>> The program will be adjusted/added.

>> Display will return to “Program view”.

Press the cross to cancel adjustment/adding.

7.4.5.1.2 Activate a program

Press the grey point on the right side of the program.

>> The point will change position upwards and go green.

The most recently activated timer program dictates operation of the air handling unit.

7.4.5.1.3 Deactivate a program

Press the green point on the right side of the program.

>> The point will change position downwards and go grey.

7.4.5.1.4 Remove a program

Programs for timer-controlled ventilation can be removed from the list.

Press the square to left side of the program to be removed.

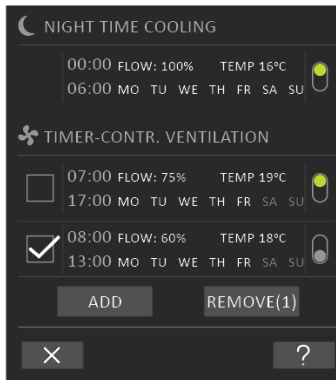

>> The program will be marked with a tick. The function button “Remove” shows the number of programs to be removed.

Press the function button “Remove” to remove the programs selected or press the cross to cancel.

>> Programs will be removed.

>> Display will return to “Program view”.

The program “Night time cooling” cannot be removed.

7.4.5.2 Date and Time

Date and time are preprogrammed according to the calendar. Time changes automatically to summer and winter times. The summer/winter setting can be deactivated using the Airlinq Service Tool.

The control system software date and time synchronizes automatically with date and time on a connected PC, but can also be set directly.

Press “DATE” or “TIME”.

>> Set date or time.

7.4.5.3 Default flow

The standard air flow (default flow) is used by the Airlinq control system when the air handling unit is started using sensors or external contacts.

Press “DEFAULT FLOW”.

>> Set default flow in % (Default 80%).

7.4.5.4 Default temp

The standard inlet temperature (default temp) is the setpoint for the unit’s required temperature level. Standard setting is 19°C. The temperature can be set to max. the required room temperature.

Press “DEFAULT TEMP”.

>> Set inlet temperature in °C.

The Airmaster unit can not be used to heat a room by increasing inlet temperature. Room temperature regulation must be performed using a heater installed in the room.

7.4.5.5 High temperature

High temperature is programmed at 25°C. At this room temperature, the upper limit of the temperature range described as “comfort temperature” is exceeded.

If the unit detects that this limit is exceeded during operation the control system will start a cooling process to reduce the current room temperature. See section High temperature (High Temp) on page 12.

This temperature setting does not generally need to be changed.

Press “HIGH TEMPERATURE”.

>> Set high room temperature in°C.

To ensure trouble-free operation, we recommend programming a high room temperature higher than the normal room temperature.

7.4.5.6 Reset service

After a regular service with filter change, the filter change timer must be reset.

Press “RESET SERVICE”.

>> Enter the code (Standard “9732”) and confirm. See section 7.4.6 Lock screen on page 35.

7.4.5.7 Data Log

Airmaster units have a continuous data log. When the memory is full, the oldest data is overwritten first. If a fault is detected on the unit, a time-limited data log can be activated.

Press “DATA LOG”.

>> Set log interval (log period is calculated automatically) or set log period (log interval is calculated automatically).

>> Activate data log - All data in the memory is deleted, and the data log starts.

When the data log is completed, a pop-up text appears on the control panel: “Time-limited data log completed. Download data to a PC with Airlinq Service Tool”.

The log period depends on the logged parameters. In the event of rarely occurring faults, the interval or period can be extended, and in the event of frequent faults, the interval can be shortened. After transferring to a PC, the data log can be automatically sent for analysis by (e.g.) your service partner.

Please contact your service partner by phone or mail to agree service provision.

7.4.5.8 Startup Guide

The startup guide starts automatically when the unit is started for the first time. The guide can also be started manually, in the “Setup” menu.

The most important settings can be made using the startup guide. The guide must be run completely. When making settings, the guide jumps automatically to the appropriate menu point and back.

Startup guide menu points:

- Set Default flow, see page 33.
- Set Default temp, see page 33.
- Set High temperature, see page 34.
- Set Date and Time, see page 33.
- Set Night Time Cooling and Timer-Controlled Ventilation, see page 31.

- Set CO₂ level lower limit and upper limit and Start/Stop of the unit with CO₂ sensor, see page 9.
- Set the code for the screen lock (see below) and the service reset, see page 34.
- Set the activation of the screen lock, see below.
- Start unit (starts the unit with the current programming and terminates the startup guide).

7.4.6 Lock screen

The control panel can be locked to prevent accidental operation using the screen lock.

7.4.6.1 Activate screen lock

Press  "LOCK SCREEN"

>> The screen will lock immediately. The control panel will show the main screen.

The screen lock is protected by a 4 digit code (Default: "9732"). The code can be changed, and the activation of the screen lock can be changed to manual, automatic or inactive by using the Startup Guide or the programs Airlinq User Tool and Airlinq Service Tool.

7.4.6.2 Deactivate screen lock

Press padlock on the control panel main screen and drag in direction of arrow.



Set code:

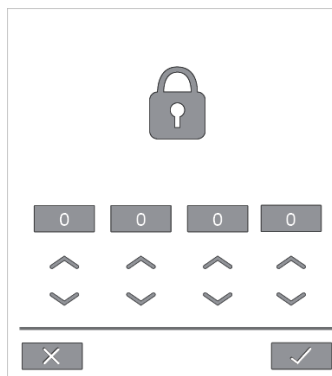

Set code by pressing the up arrow to increase the value, and down arrow to reduce it.

Press tick.

>> The screen will be unlocked.

7.5 Indoor climate level

If the air handling unit is equipped with a CO₂ sensor the room's current indoor climate level will appear on the control panel.

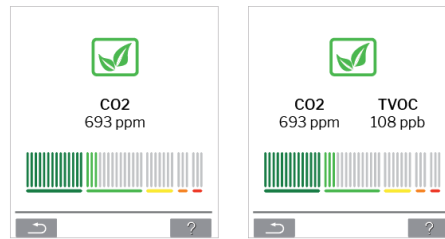

When the sensor sends a signal to the air handling unit, the indoor climate symbol appears on the main menu of the control panel. Depending on the level, the symbol appears dark green, light green, yellow, orange or red.

Press symbol (pos. 5 in section 7 Airlinq Orbit control panel on page 23).

>> The indoor climate status appears.

7.6 Airlinq BMS

When using Airlinq BMS with up to 20 air handling units and 20 cooling modules, the system is usually broken down into several groups (G) with at least one unit (ID) each, with all units in a group controlled uniformly.

One of the units in a group will be programmed as the "Group Master", which controls the entire group. Multiple sensors and a group control panel can be linked to each group. The units can also be equipped according to local conditions

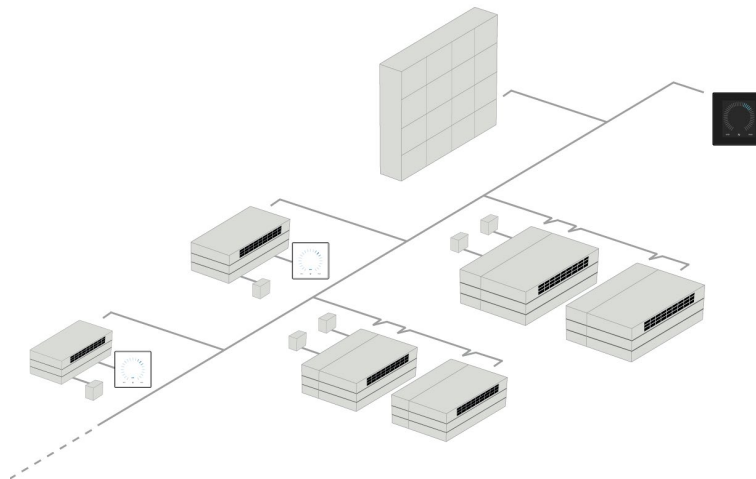

We recommend that you create a system description, an example can be seen on the next page.

7.6.1.2 Start

7.6.1.2.1 Start or restart automatic operation for a group/several groups

Press the function button.

>> The control menu will appear.

Select the groups to be started and press menu field " AUTO".

>> The group selected will start according to the programming.

7.6.1.2.2 Start operation manually

Press the function button.

>> The control menu will appear.



Select the groups to be started and press menu field " START".

>> The group will start with standard air flow and standard inlet air temperature (see page 33). The text "auto" will show with blue light. After 4 hours (time can be adjusted to OFF, 0, 1, 2, ... 255 hours using a PC running Airlinq Service Tool) or at the next stop signal from a timer program, the group will return to automatic operation.

7.6.1.3 Standby

Press the function button.

>> The control menu will appear.

Select the groups to be stopped and press the menu field "  STANDBY".

>> The groups will stop in 1 hour (time can be adjusted to 0, 1, 2, ... 255 hours using a PC running Airlinq Service Tool) and then start at the next start signal. Otherwise, the groups can be started earlier by using the "start" menu field. The air flow indicator will flash slowly alongside minimum.

7.6.1.4 Switch Off

7.6.1.4.1 Switch off a group/several groups

Press the function button.

>> The control menu will appear.

Select the groups that should be switched off and press the menu field " OFF".

7.6.1.4.2 Switch off system

Press the function button for min. 2 seconds, if the system or at least one group is running.

>> All units will switch off.

After switching off, the groups / the system must be started manually using the menu fields "AUTO" or "START".

7.7 Warnings and alarms

In the event of warnings and alarms, a triangle with an exclamation mark in its center with a yellow or red light (pos. 4 in section 7 Airlinq Orbit control panel on page 23) will show in the top left hand corner of the control panel main screen.



Press the symbol.

>> The control panel will show a large triangular warning/alarm text and “call SERVICE” for alarms, plus a telephone number. In the event of several warnings or alarms, they will be shown in order of priority:

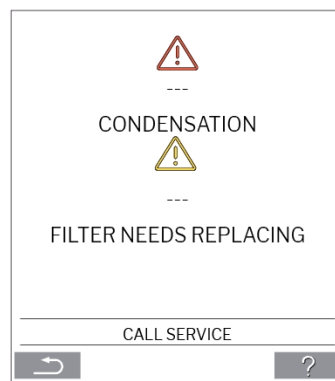
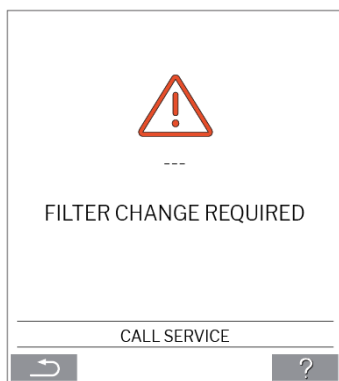

Display of warnings and alarms with the unit's ID number in an Airlinq BMS system:

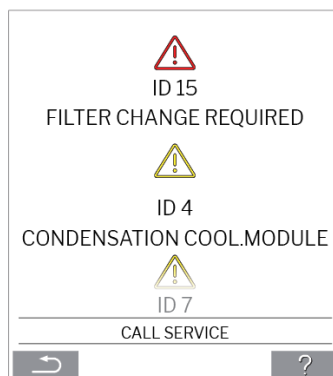

An ID number can be changed to another designation in Airlinq Service Tool.

7.7.1 Warnings (yellow triangle)

The air handling unit remains in operation in the event of a warning, but operation can be limited.

- Compressor locked (stopped)
- Filter needs replacing
- Group Master Missing. (Airlinq BMS only)
- Technical faults (Temperature sensors (RT, OTV, OT, EVi, EVo or HG), flow measurement or CO₂ sensor.

7.7.2 Alarms (red triangle)

The air handling unit will stop to prevent damage in the event of an alarm.

- Low temperature
- Condensation (in the air handling unit)
- Filter change required
- Critical fault (Temperature sensor (IT, ETV), supply air fan or extract air fan).

8 Airlinq® Online

Airlinq® Online is a professional web portal for Airmaster air handling units connected to Ethernet.

The portal is a cloud-based service, and the servers that handle communication with the systems are located in 'the cloud'. All communication is securely encrypted. Airlinq® Online is designed to control, monitor and manage ventilation solutions for one or more installations.

The access to Airlinq® Online is possible from a smart phone, a tablet, or a personal computer. There is no need to install any software or application. All you need is internet access through your internet browser.

8.1 Login

When activated your access to the service through the Airmaster Airlinq® Online invitation email go to: www.online.airlinq.eu in your browser to login to Airlinq® Online.

When you log onto Airlinq® Online, you will always see an administration page first. The administration page provides a full overview of all of your air handling units.

The screenshot displays the 'Device overview' page in the Airlinq Online web portal. The page features a navigation bar at the top with 'AIRLINQ ONLINE', 'Firmware', 'Devices', 'Groups', 'Help', and 'Profile'. Below the navigation bar, there are filters for 'Small view', 'Filter: Academy', and 'Devices in total: 5'. A search bar is also present. The main content is a table with the following columns: Name, Airflow, Operation, Air quality, Temperature, and Status. The table lists five air handling units with their respective parameters and status indicators.

Name	Airflow	Operation	Air quality	Temperature	Status
AM300 Part#: - AM300 AM 300 - S/N: 0000000	30%	Started by Timer System mode: Auto	CO ₂ : 439 ppm TVOC: 149 ppb	Room: 20.7°C	Filterchange needed Low temp process
AM500+CC Part#: - AM500+CC AM 500 - S/N: 0000000	30%	Started by Timer System mode: Auto	CO ₂ : 437 ppm TVOC: 128 ppb	Room: 21.3°C	Filterchange needed
AM900 Part#: - AM900 AM 900 - S/N: 0000000	30%	Started by Timer System mode: Auto	CO ₂ : 437 ppm TVOC: 51 ppb	Room: 20.9°C	High temp process
Academy - Showroom Part#: - Academy - Showroom AMX 4 - S/N: 0000000	100%	Started by Timer System mode: Comfort	CO ₂ : 609 ppm RH: 31 %	Room: 23.6°C	OK
Undervisningslokale Academy Part#: - Undervisningslokale Academy AM 1000 - S/N: 0000000	30%	Started by Timer System mode: Auto	CO ₂ : 431 ppm TVOC: 114 ppb	Room: 20.4°C	OK

At the bottom of the page, there is a footer with 'AIRMASTER', contact information '(+45) 9867 4822 info@airmaster.dk Terms and Conditions', and social media icons for LinkedIn and Facebook.

9 Service and maintenance

Service and maintenance are vital for problem-free operation of an Airmaster unit and its equipment. The majority of servicing consists of cleaning and inspection of the condensate system and filter change. We recommend that all service is performed by authorized experts.



WARNING

The unit must be switched off, disconnected from the mains and prevented from being switched on (LOTO) before the service door is opened.

9.1 External cleaning

To remove dirt from the control panel, sensors, and air handling unit, use a soft, damp cloth and clean water, or water with a mild detergent added (e.g. washing up liquid).

Do not use aggressive substances (e.g. turpentine) or sharp objects (such as a scraper) to clean the ventilation system components.

The extract air grille and air vents must be cleaned regularly. We recommend vacuum cleaning using a soft brush nozzle.

The space between the air handling unit and ceiling can be dusted using a feather duster. A soft brush vacuum nozzle can also be used if there is sufficient room.

9.2 Internal cleaning

Internal cleaning is recommended when changing filter. If dirt gets in to the unit, remove it with a vacuum cleaner or soft brush.

Check the cleanliness of components when performing internal cleaning. This applies in particular to the counterflow heat exchanger and fans.

9.3 Cleaning the condensate system

The condensate system must be cleaned minimum annually and must be controlled at every filter change.

A condensate tray is fitted as standard to all units. The plug, drain house and tray can all easily be removed for cleaning the drain and hose. All condensate hoses in the condensate system must be secured again with a suitable hose clip.

The condensate pump is an option hence it might not be part of your unit.

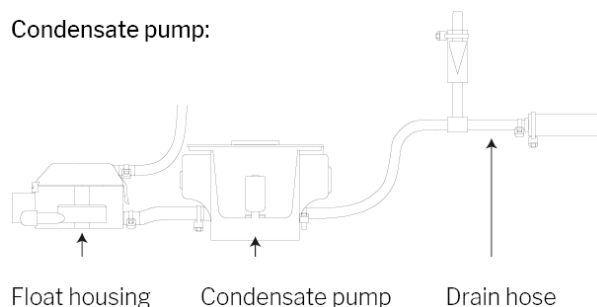

Pour approx. a half liter of water into the condensate tray, switch on the power briefly and check that the water is pumped out and that there are no leaks. *We recommend cleaning the drain and hose when changing the filter.*

9.4 Filter change

All filters in the air handling unit are monitored by the unit's filter monitoring system.

Replace the filters whenever the monitoring system indicates that a filter must be changed, but at least every 14 months.

Please be aware of any specific, deviating local rules.

Filter monitoring can be adapted to local conditions using Airlinq Service Tool. The filters are tested automatically on a daily basis (time can be set using "Airlinq Service Tool"). The control system filter monitoring must be reset after a filter change.



NOTICE

Used filters must be disposed of according to their contamination with particles (waste code 1502), atmospheric particles (waste code 150203) or 'hazardous' substances (waste code 150202).



CAUTION

Used filters must be disposed of in a dustproof bag immediately after they have been removed from the unit.



CAUTION

Use appropriate safety equipment such as safety goggles, disposable gloves, and a dust mask when changing the filters.

9.4.1 AM 950 C filter location

The AM 950 C has two filters, one is located on the right-hand side of the unit, the other is located on the left-hand side. You need to open the two service covers and the steel bottom plates to access each of the filters.

Unlock and open the service cover.

The service cover is designed to hang from the unit without falling.

Take care not to bump into the service cover when it is hanging down.

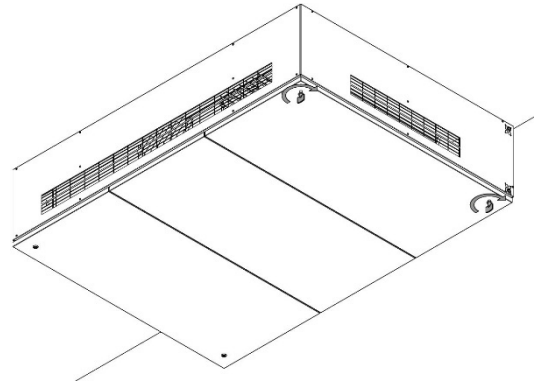

Loosen the bolts in the keyholes.

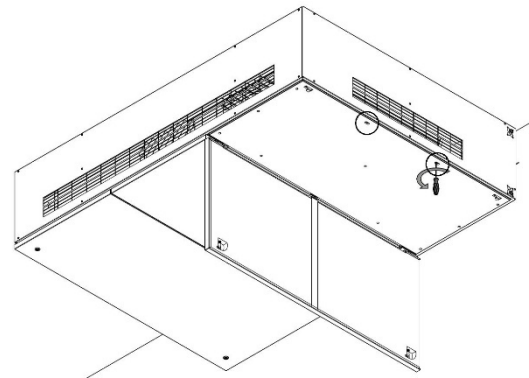

Unscrew the nine bolts marked with a circle.

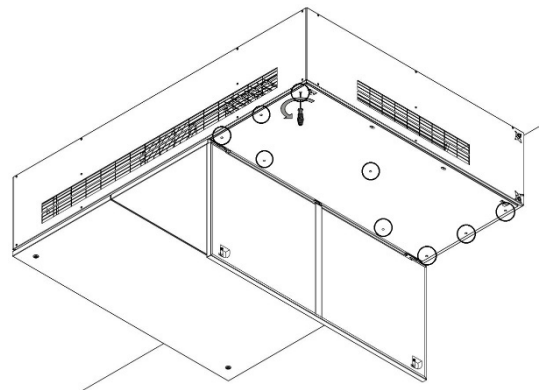

Push the steel plate towards the front of the unit so the bolts are in the wider part of the keyhole.

The steel plate is designed to hang from the unit without falling.

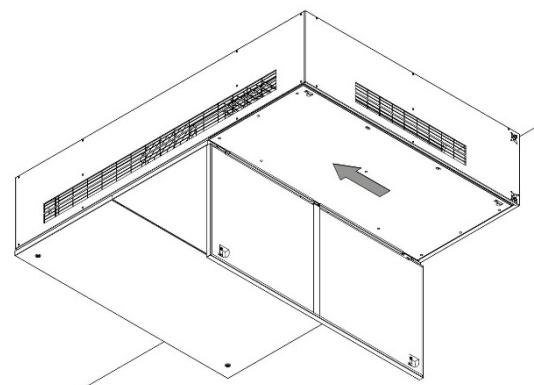

The filter is located to the right.

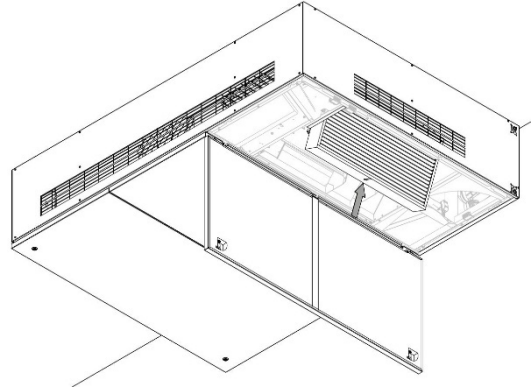

You access the other filter the exact same way. Unlock and open the service cover, then the steel plate.

The filter is located in the rear part.

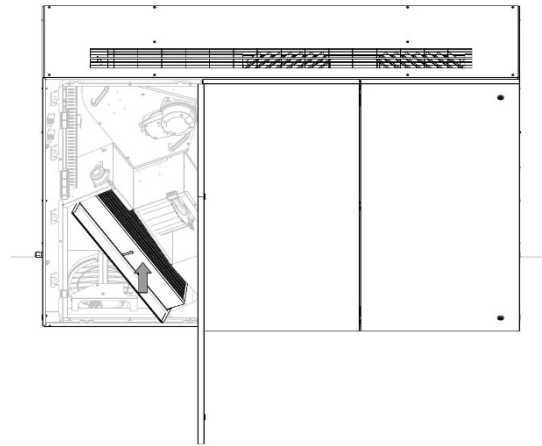

9.4.1.1 Filter change

Open the filter retaining panel.

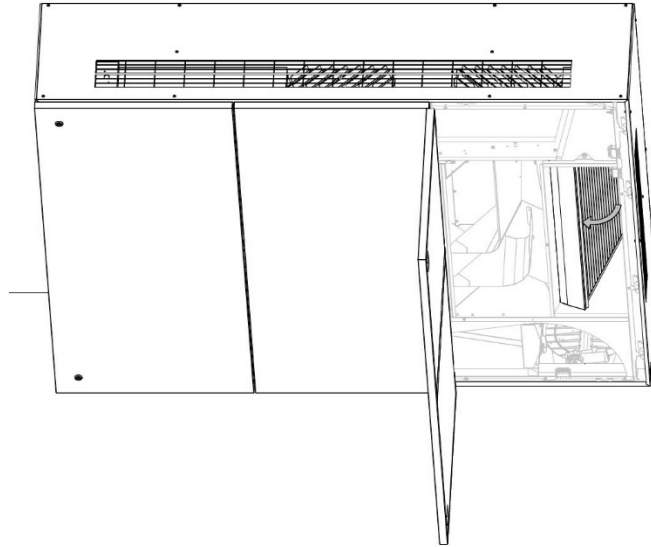

Pull the old filter out.

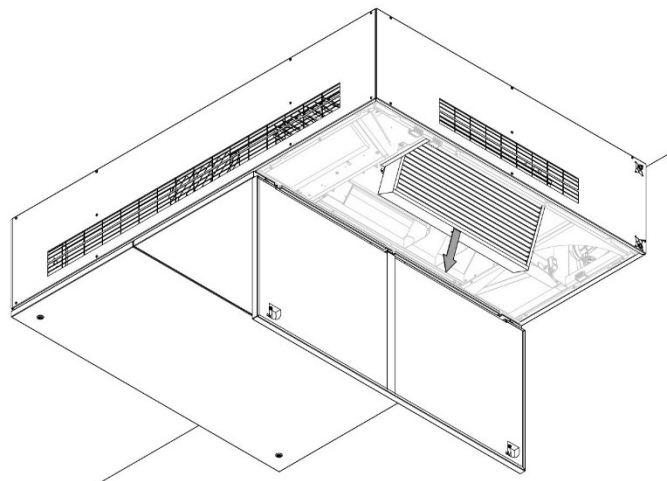

Replace with a new one.

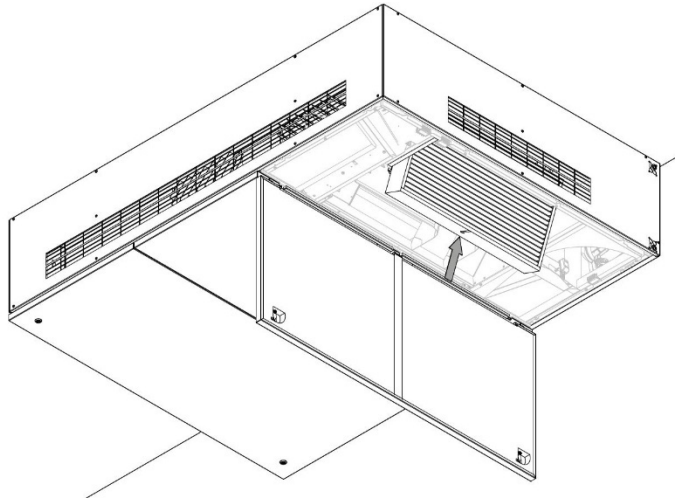

Make sure the arrow on the new filter is pointing towards the middle of the unit.

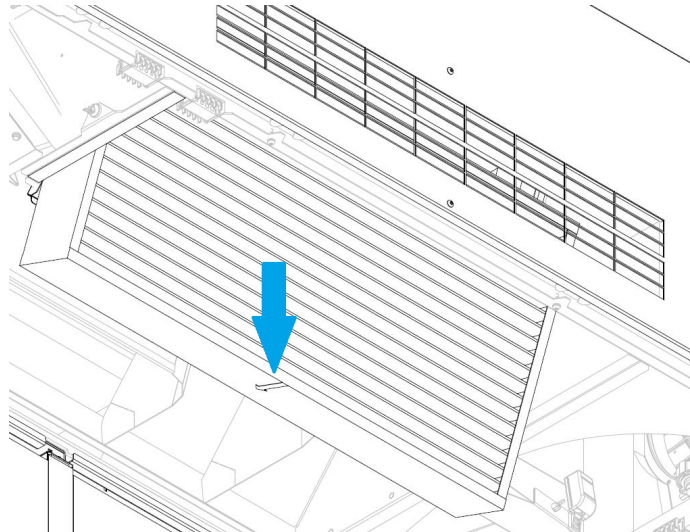

Close the filter retaining panel.

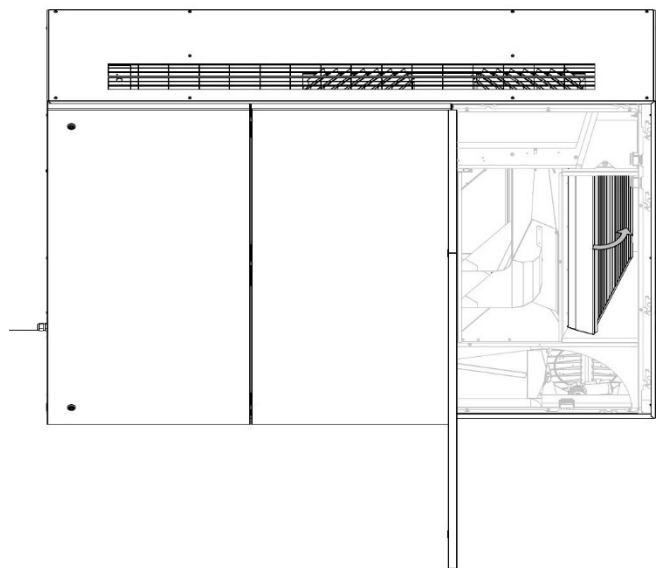

Do the exact same on the other side of the unit.

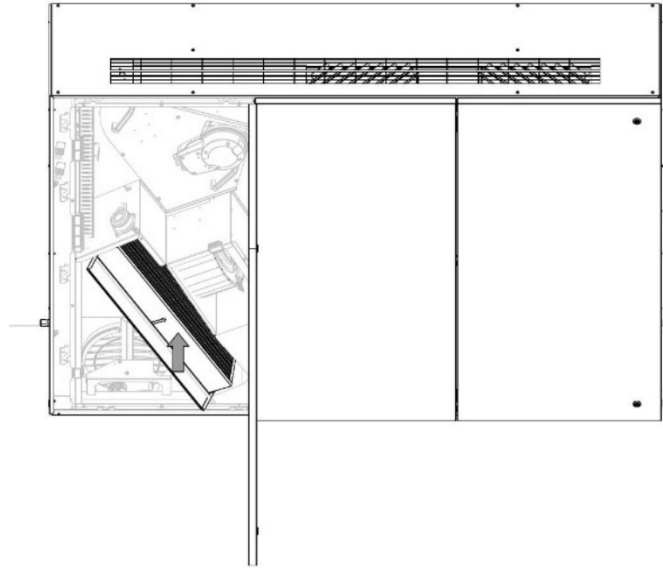

Make sure the arrow on the new filter is pointing towards the middle of the unit.

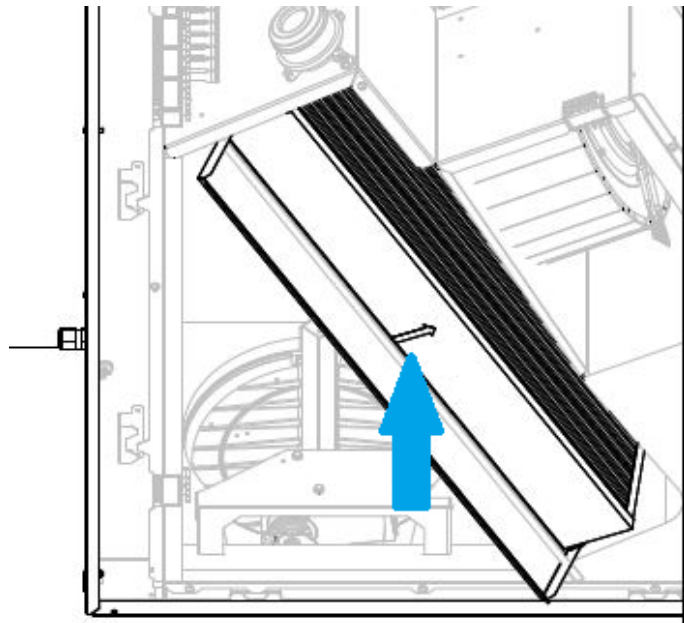

Close off the unit by reversing the steps in section 9.4.1.

9.4.2 AM 950 F filter location

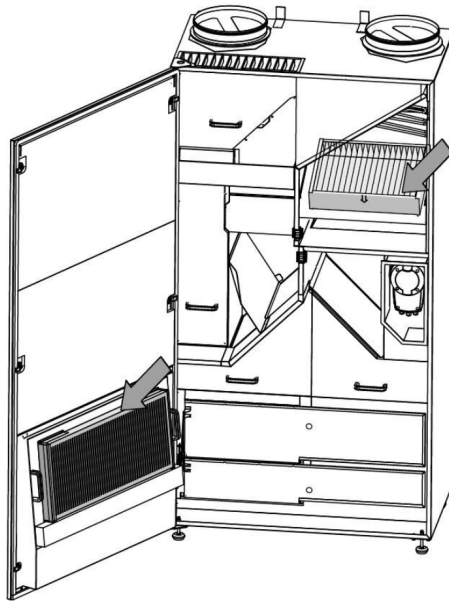

9.4.2.1 Filter change

1. Open the service door.
2. Open the filter retaining panels on the service door filter and pull the old filter out. Lift the inside filter up and pull it out.

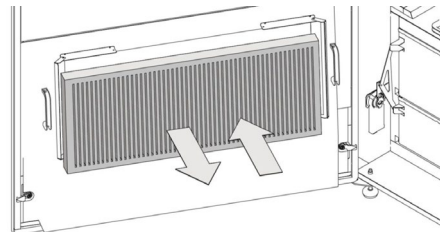
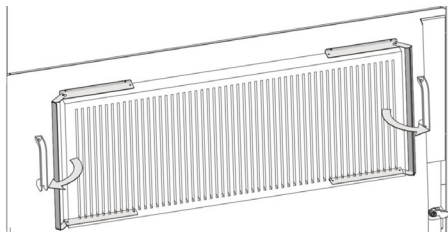

Service door filter (extract air filter)

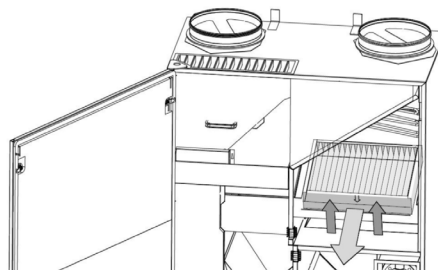

Inside filter (supply air filter)

3. Clean the inside of the unit and the supply air passages. Check the condition and cleanliness of the components, clean if necessary.
4. Insert new filters. Make sure the filters are inserted correctly: the arrow on the side of the new filters must point into the unit:

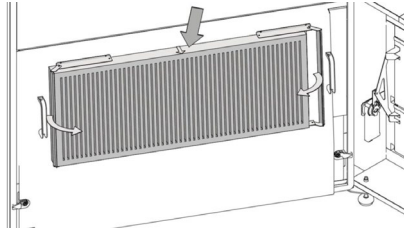

Service door filter (extract air filter)

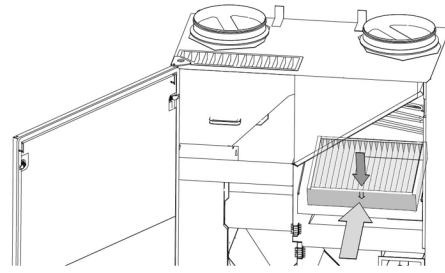

Inside filter (supply air filter)

5. Close the filter retaining panels on the service door filter.
6. Close the service door.
7. Turn the power back on and start the unit.
8. Reset service, see description in the next section.

9.4.3 Reset service (filter change)

Reset the filter alarm under control panel menu "Settings - Reset Service" or using a PC running Airlinq Service Tool.

>> Press "Confirm" to reset service or "Cancel" to cancel the reset.

>> Enter the code (Standard "9732") and confirm.

Units with no control panel:

The filter change alarm must be reset using a PC running Airlinq User Tool, Airlinq Service Tool or Airlinq Online.

9.4.4 Filters

Supply air filter: Glas fiber filter ePM₁₀ 50% or ePM₁ 55%.

Glass fiber filter ePM₁ 80% can also be used in the AM 950 C unit, please note that it is a special item.

Extract air filter: Glas fiber filter ePM₁₀ 50%.

9.5 Smoke detector, AM 950 C

Please refer to the Oppermann manual for service and maintenance. The manual is part of the delivery.

The smoke detector is located in left-hand side, towards the front section of the unit:

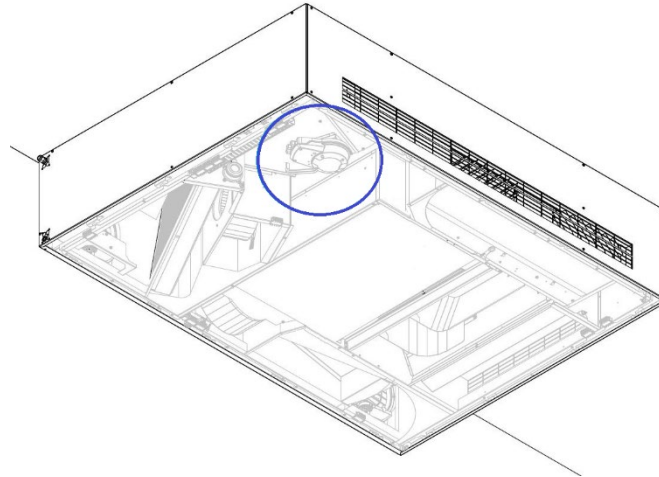

9.6 Smoke detector, AM 950 F

Please refer to the Oppermann manual for service and maintenance. The manual is part of the delivery.

The smoke detector is located in the front section of the unit:

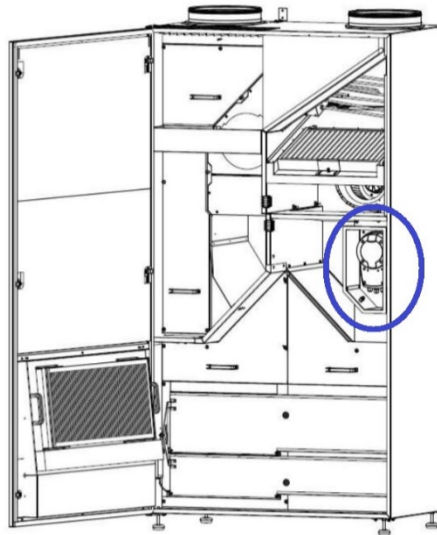

9.7 Setting the inlet air grille

By changing the slat angles, you can change the throw and dispersion of the air, see general examples below:

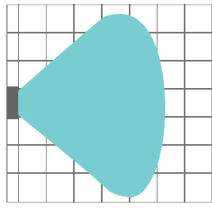

Standard dispersion and throw

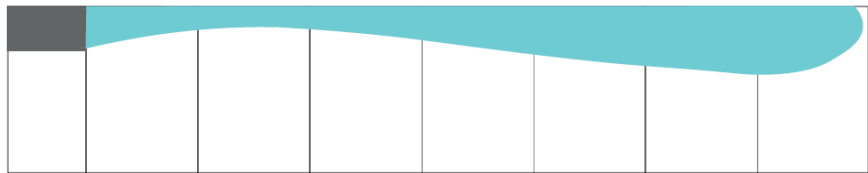
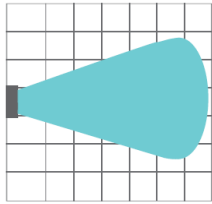

Reduced dispersion resulting in a longer throw

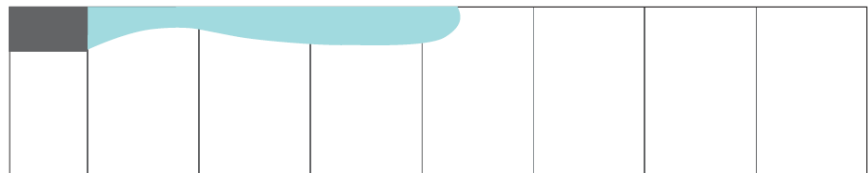
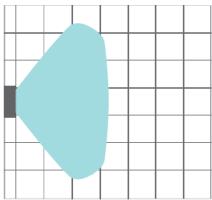

Wide dispersion resulting in a short throw

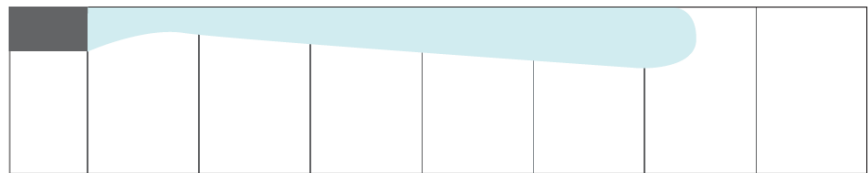
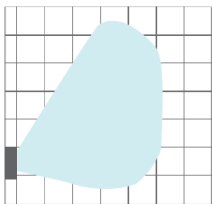

Asymmetrical dispersion, either to the left or the right

9.7.1 Inlet air grill location

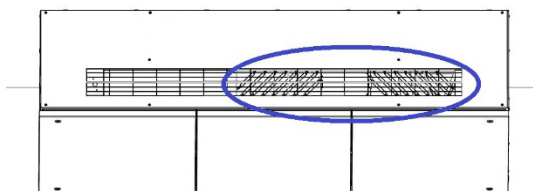

AM950 C

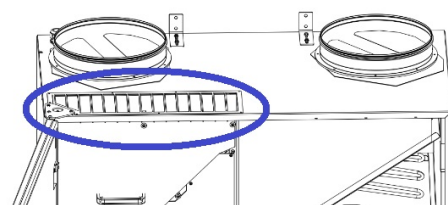

AM 950 F

The inlet air grille slats can be bent slightly using long nosed pliers to adjust the inlet direction. See the next page.

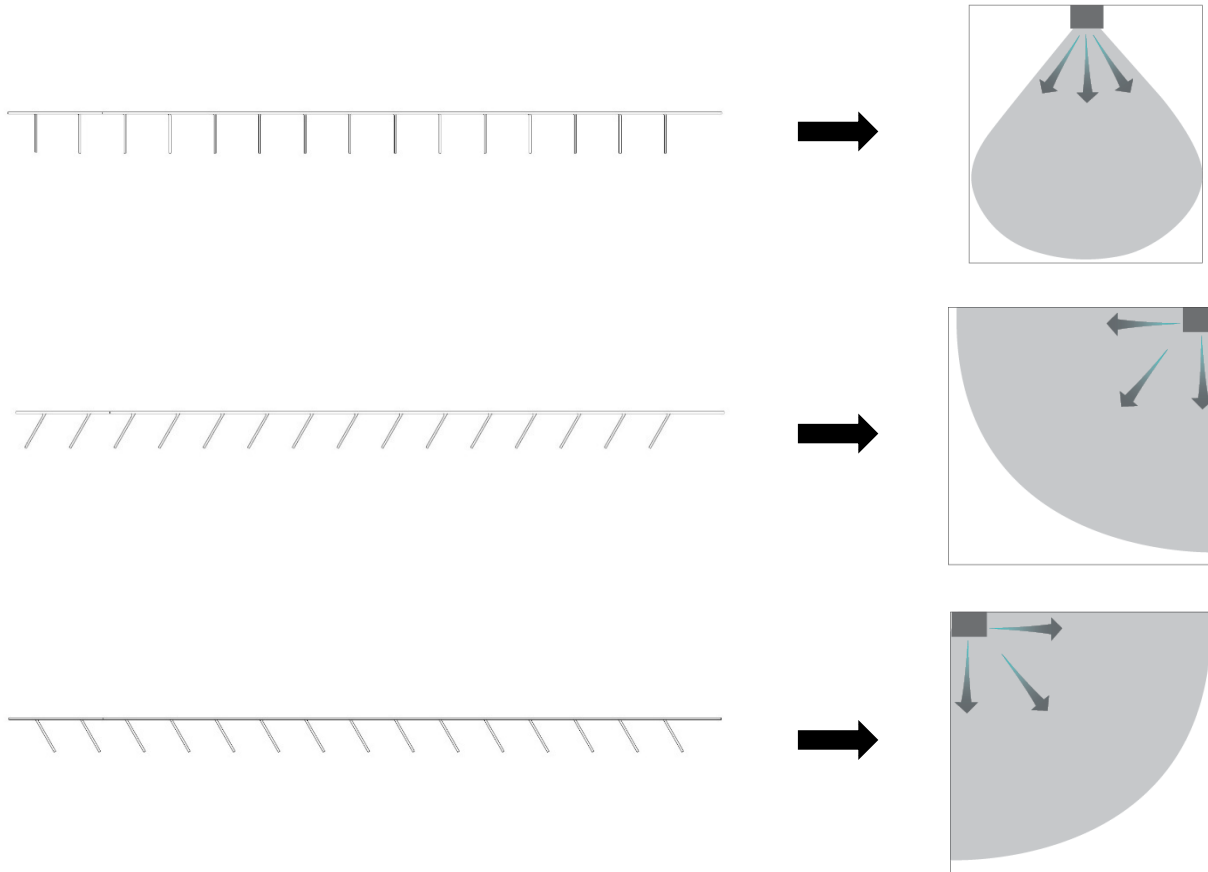

The following label is located directly below the air inlet. It will help you adjust the slats:



NOTICE: *It is only possible to bend the slats a few times, otherwise they can break off.*

10 Error description

Error: Control panel blank.

1. The unit is switched off.
Start the unit manually. See page 26.
2. No electricity supply.
Switch on mains electricity.
3. Control panel or data cable defective.
CALL SERVICE.

Error: Unit cannot be operated.

The control panel operates in automatic mode, child or screen lock active.
Deactivate lock. See pages 24 or 35.

Error: Control panel air indicator flashing.

Data connection from control panel to unit broken.
CALL SERVICE.

Error: Unit blowing too cold air.

1. The inlet temperature is set too low.
Check setting. See page 33.
2. Room heater set too low.

Error: Draft from the unit, the room feels cold.

1. Inlet temperature set too low.
Check setting. See page 33.
2. The air flow too low. Increase air flow.
3. Room heater set too low.
4. The inlet opening slats are not set correctly. See page 53.

11 Repairs and improvements

All repairs and improvements must be performed by authorized experts.

The AQC-L control box contains a varistor that protects against overvoltage. In the case of a defective control box, this glass fuse must be checked. Replace if faulty.

Please contact your service partner by phone or mail to agree service provision.

12 Dismounting

Should the unit need to be dismantled, follow the installation in reverse.



WARNING

The unit must be switched off, disconnected from the mains and prevented from being switched on (LOTO) before the service door is opened.

1. The ventilation unit is dismantled.
2. Electricity connection is disconnected.
3. The internal part is dismantled.
4. The outside part is dismantled.
5. The hole in the wall is closed.

13 Disassembly

Product information according to "Commission Regulation (EU) No 1253/2014, annex IV – Information requirements for RVUs as referred to in Article 4(1)" and product information according to "Commission Regulation (EU) No 1254/2014, annex IV – Product fiche as referred to in Article 3(1)(a)" can be found on our website.

Go to: [Downloads](#), choose 'Disassembly'.

It contains a description of the required tools and procedures for manual disassembly for the effective recycling of materials.

14 Disposal



NOTICE

Electrical and electronic equipment (EEE) contains materials, components, and substances that may be hazardous and present a risk to human health and the environment when waste electrical and electronic equipment (WEEE) is not handled correctly.

Disposal must be carried out by authorized professionals following local applicable legislation and rules.

The unit must not be disposed of as domestic waste.

Air handling units and cooling modules contain among other things electric and electronic equipment that must be disposed and recycled according to local rules and by-laws. The unit must not be disposed of as domestic waste.

Cooling modules must be drained of coolant and oil according to local rules and by-laws before disposal.

Appendix A EU Declaration of Conformity

AIRMASTER

EU Declaration of Conformity

Manufacturer Airmaster A/S
Industrivej 59
DK-9600 Aars
Denmark

Herewith declare that the following air handling unit (series and type (serial numbers))

Product AM 50 (0500001-0501720)
AM 150 (3404252-3499999)
AM 300 (3000006-3099999)
AM 500 (0314234-0399999)
AM 800 (0908896-0999999)
AM 900 (0501721-0599999)
AM 950 C (8100001-8199999)
AM 950 F (8200001-8299999)
AM 1000 (1002448-1099999)
AM 1200 (0800422-0899999)
AM 150 (3404252-3499999) with CC 150 (3600426-3699999)
AM 500 (0314234-0399999) with CC 500 (1300768-1399999)
AM 800 (0908896-0999999) with CC 800 (1400864-1499999)

is in conformity with provisions of the following EC directives:

Directives Directive 2006/42/EC of the European Parliament and of the Council of 17 May 2006 of machinery.
Directive 2014/30/EC of the European Parliament and of the Council of 26 February 2014 on the harmonisation of the laws of the Member States relating to electromagnetic compatibility.
Directive 2009/125/EC of the European Parliament and of the Council of 21 October 2009 establishing a framework for the setting of ecodesign requirements for energy-related products.
Directive 2011/65/EU of the European Parliament and of the Council of 8 June 2011 on the restriction of the use of certain hazardous substances in electrical and electronic equipment.

Reservation This declaration is not valid if modifications are made to the product without approval by Airmaster A/S.

Place Aars

Date 2025-04-30

Signature 
Jesper Mogensen
CTO

This page is intentionally left blank

This page is intentionally left blank

AIRMASTER

16107_REV02.2_2026-06-23

Errors, omissions and changes excepted. Original user instruction.